

A

I R G A G I N G

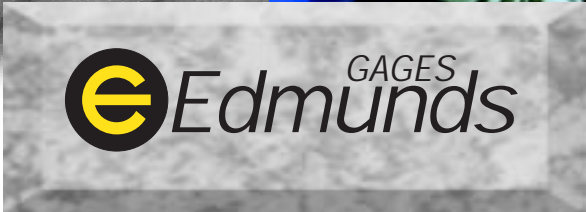

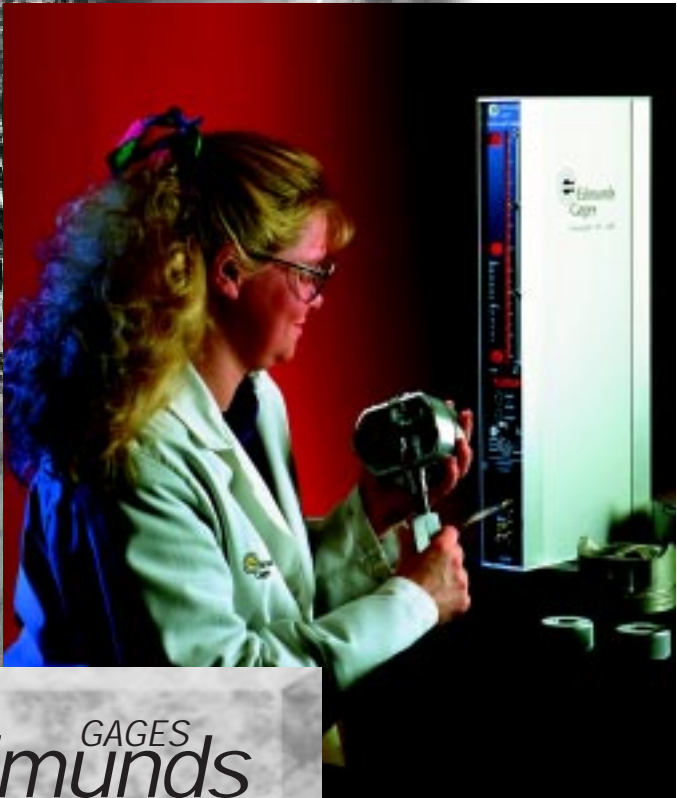

Contents

Air Gaging Basics 2-3

Air Gaging Applications 4-5

Glossary of Air Gaging Terms 6

Components of an Air Gage 7

A Brief History of Air Gaging 8-9

Air Gaging Systems

 Back-Pressure Bleed, Back-Pressure,
 Flow, Differential 10-11

The Edmunds Air Gaging System

 Accu-Setter™ and Trendsetter™

 Amplifier Columns 12-13

Edmunds Air Tooling

 Back-Pressure Bleed 14-15

 Back-Pressure 16-17

 Flow 18-19

 Differential 20

Air Snaps 21

Masters 21

Accessories 21

Other Edmunds Products and Services 22

Air Gage Ordering Worksheet 23

Why Air Gaging?

Air gaging is a non-contact means of precise comparative dimensional measurement which offers users the advantages of improved workflow, increased productivity, and decreased downtime. It is ideal for measuring dimensions with tolerances smaller than .005", and when gaging tight tolerances, a resolution as small as .000002" can be achieved. Its non-contact characteristic makes air gaging particularly useful for checking soft, highly polished, thin-walled or other delicate materials.

Chief among the benefits of air gaging is its ease of use, which produces accurate results even when operated by unskilled employees. Operation is as simple as presenting a tool to a workpiece and observing a reading. Air gaging operation is fast, as well. A row of multiple column amplifiers can be scanned in one glance, reducing time and fatigue. And relationships — squareness, for example — that cannot be checked by fixed limit gaging and are costly by other means, are easily measured with air gaging.

Air gaging is economical, too. Once the basic system is purchased, relatively inexpensive additional tooling can be used for a wide variety of applications. Air gages effectively measure all common types of dimensions and are particularly suited to measuring dimensional relationships and match gaging.

Most air gaging systems operate at air pressures which can purge workpieces of contaminants such as abrasive particles and coolant at the measurement point, eliminating the need for a separate cleaning in most operations. And, since air gage tooling has no moving parts, it is virtually immune to fouling. Air gaging offers a wide choice of tooling for single or multiple measurement applications, and when repair is needed, air tooling is the easiest to repair.

A brief examination of the fundamentals of air gaging will show how the basic premise of air gaging and its evolution into today's manufacturing environment achieves those advantages.

What is Air Gaging and How Does it Work?

To achieve its precise dimensional measurement, air gaging relies on the laws of physics which state that flow and pressure are directly proportionate to clearance and they react inversely to each other.

The regulated air flows through the restriction — a needle valve, jeweled orifice, etc. — and then through the nozzle. When the nozzle is open to the atmosphere, there is maximum flow through it and there is a minimum of pressure — called “back-pressure” — between the restriction and the nozzle.

As an obstruction is brought increasingly close to the front of the nozzle, air flow from the nozzle diminishes and back-pressure builds. When the nozzle is completely obstructed, air flow is zero, and back-pressure reaches the pressure of the regulated air supply. During this example, air flow moved from maximum to minimum, while back-pressure moved in the opposite direction: minimum to maximum.

These values can each be plotted against the nozzle’s clearance from the obstruction. Except for the extremes of both back-pressure and flow, the curves are straight-line, representing the linear proportions which establish the basis of all air gaging.

Thus, measured decreases in flow provide an accurate correlation of the distance of the nozzles in the air gage tool to the obstruction: the surface of the workpiece being measured. Similarly, back-pressure increases indicate less distance between the tooling nozzles and the workpiece.

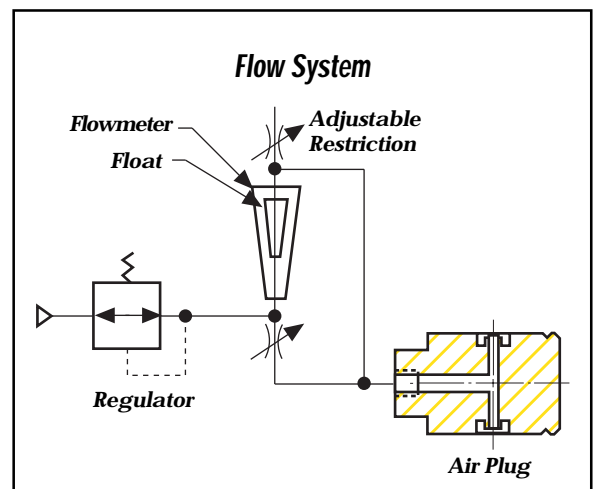
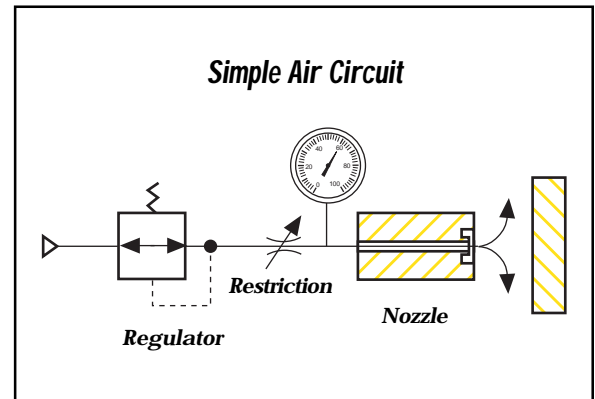
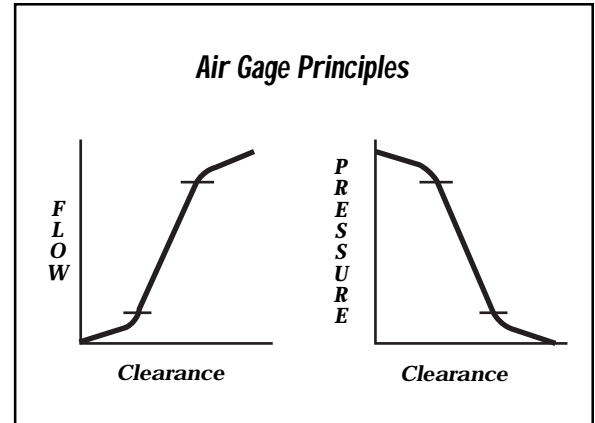

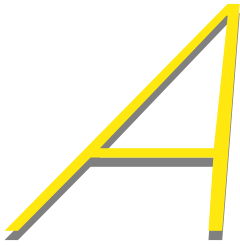

Air Gaging Applications

Edmunds makes complete, integrated air gaging systems: amplifiers, tooling, setting masters, connectors and accessories. When you purchase a complete system, you are assured of consistent quality.

The adjustable magnification of the Edmunds back-pressure bleed system makes adaptability to many applications effortless within broad ranges of tolerance. We show several here, and many more are possible. We want to discuss your measurement needs, and how Edmunds air gaging can fill them economically, with precision and with long-lasting quality.

Furthermore, that same Edmunds quality is reflected in the production of tooling for other systems, as well. All our tooling is engineered to the application, designed to optimize wear life for the system it's being used on, and tested on the systems for which it's engineered before it leaves our factory.

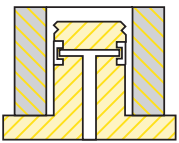

Inside Diameter

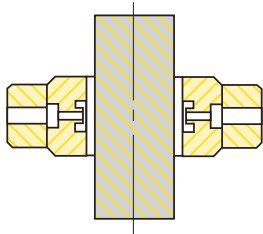

Outside Diameter

Inside and Outside Diameters

Air gages are most commonly used for measuring the size and form of inside diameters and outside diameters. Two-nozzle air plugs, with nozzles diametrically opposed, are often used for internal measuring, and two-nozzle air rings are used for external dimensions.

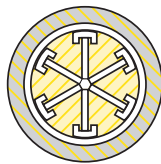

Averaging

Averaging

Multiple nozzles are equally located about the circumference of the air tool to allow for average size measurement. Commonly used for thin-walled or out-of-round parts — four, six, or more nozzles are utilized, depending on the tool size.

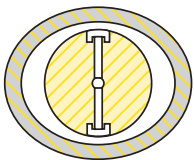

***2-Point
Out-of-Round***

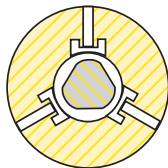

***3-Point Out-of-
Round (Lobing)***

Out-of-Round

Air tools can gage a part for roundness. For two-point out-of-round conditions, a standard two-nozzle air tool can be used. If lobing exists in the part, an odd number of nozzles must be used, depending on the number of lobes.

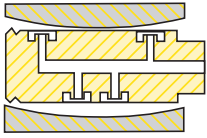

Straightness

Straightness

A common application of air gaging is to dynamically measure the straightness or “bow” of an inside diameter. In this case, a custom designed air plug makes verifying a part’s straightness simple and fast. (A straightness air plug cannot measure diameter).



Squareness

Squareness

To determine squareness of a part, for example a bore to a face, air nozzles configured as a “z” are used with dynamic measurement to change the back-pressure from square to out-of-square conditions.



Taper

Taper

Angle variation of tapered surfaces is commonly checked with air gaging as the difference of two diameters.

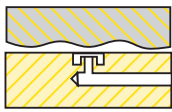

Flatness

Flatness

To measure flatness, an air nozzle is mounted within a stationary platen. The part is then moved across the nozzle. This process provides a convenient, quick method to accurately gage flatness.

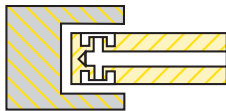

Groove Width

Groove Width

The measurement of grooves is conveniently achieved with flat, blade-type air tools. Air gaging not only determines groove size, but with exploration around the workpiece, parallelism of the groove faces can also be determined.

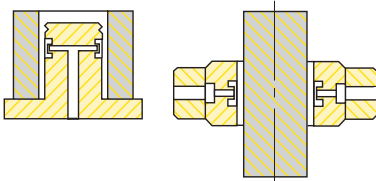

Matching

Matching

A specified clearance between two mating parts is often required to assure proper part operation. The Edmunds Accu-Setter™ amplifier allows for the individual display of the bore size, the shaft size, and the clearance between the two parts. Operators need only observe the clearance display to determine if the two components have the required match dimension.



Glossary of Air Gaging Terms

Amplifier - The readout of an air gage system. An amplifier is a device containing the necessary restrictions to change the pneumatic pressure or flow. It then displays readings on a scale as dimensional values. When connected to air gage tooling, readings are amplified many times, allowing the user to easily read the size being measured.

Balance - The resultant non-movement on the display of an air amplifier that occurs when one nozzle of a two-nozzle tool is closed toward the workpiece and the other nozzle equally compensates for that movement.

Column - An air-electronic amplifier or a flow system amplifier featuring a vertical bargraph display or flowmeter tube.

CTS - Refers to air tooling designed to measure **Close-To-Shoulder**. As an example, an air plug used to measure counterbores. Removal of front center post on air plugs below 2.510" becomes a blind hole design.

Flowmeter Tube - A graduated glass tube of a precise size with a "floating" cork that displays the readings on a flow air gage system. Several different sized tubes are necessary to accommodate all air gaging applications.

Full Scale Value (FSV) - The numeric equivalent of the graduated display. FSV is usually 1-1/2 to 2 times greater than the tolerance being measured to show approach or oversize conditions.

Magnification - The visual increase of size that is created by an air amplifier. In systems where the air amplifier has adjustable magnification, this is accomplished by adjusting the flow or back-pressure within the amplifier to agree with the master sizes. On systems that have an air amplifier with fixed magnification, it is essential that the air gage tooling is precise so that full amplification can be achieved.

Nozzle - The orifice in the air gage tooling that emits the air which blows against the part being measured. The diameter size of the nozzle is dictated by the air gage system used. The quantity and location of nozzles are determined by the measurement application.

Nozzle drop - The engineered distance that a nozzle is recessed below the surface of the air gage tool. Nozzle drop is governed by the air gage system. A deeper nozzle drop can provide longer wear life of the air gage tool.

Resolution - The smallest increment on the full scale display of the amplifier. For example, the Edmunds air-electronic columns have a full scale with 100 graduations. Therefore, the resolution is 1/100th of the full scale value.

Restriction - A device used to control air pressure or flow within an air gage amplifier. This may be done with a fixed orifice of a precise size, with adjustable needle valves, or with both.

Zero - The process of positioning the magnified spread on an amplifier to a desired relative position on the scale. Zero is generally at midpoint of the full scale, but the spread may be positioned anywhere on the scale.

Zero Size - The desired midpoint or nominal size of the feature being measured as it relates to the scale. On back-pressure systems, zero is usually the midpoint between the minimum and maximum allowable size. On the flow system, the zero size is generally the minimum size.



Components of an Air Gage

Air gages, past to present, measure either flow or back-pressure; all have the following components in common:



A precision air regulator – to provide consistent air pressure to the amplifier. Depending upon the system, this may be as little as 10 psi or as much as 44 psi.

Tooling – plugs, rings, or other shapes — which deliver a specific air flow or pressure to the surfaces being measured. Each tool is configured and sized specifically for the workpiece it is designed to measure. Air tooling is designed with its nozzles recessed, to achieve the appropriate clearance for the air pressure of the system being used and to gain protection against wear or damage to the nozzles. Air tooling features vents to allow air to escape from the workpiece without creating spurious back-pressure or restriction of flow.

Air gage tooling is designed with properly positioned nozzles. For example, two nozzles are required to measure a diameter. The nozzles are balanced to assure accurate and repeatable readings when used by workers at any skill level. For instance, if a tool should be applied to the workpiece radially off-center, the decrease in air flow from the closer nozzle is offset by increased flow through the further one. Thus the flow and back-pressure for the tool as a whole remains constant.

An amplifier – which can be an air-electronic column, one of several dial-type meters, or a flowmeter tube. The amplifier provides visual representation of the size being measured, permitting the user to take readings quickly and accurately. Back-pressure systems use either columns or dials to display readings; flow systems use flowmeter tubes.

Multiple-measurement operations require viewing more than one amplifier at a time. Checking multiple measurement results from several dial readouts can be difficult. Parallel stacking of air-electronic columns or flowmeter tubes puts all the readouts into the same vertical relationship, making comparisons simpler.

Further, air-electronic columns offer a more sophisticated system for multiple-function processing, as well as output of data for printing and for SPC and other data processing uses. Air-electronic amplifier columns are discussed under the Accu-Setter™ and Trendsetter™ sections, to follow.

Setting masters – are used to calibrate air gaging systems. Depending upon the system, one or two masters — usually in the form of discs or rings — are used. Two masters are recommended for absolute accuracy, the compelling reasons for which are discussed in the Back-pressure Bleed System description.

Masters are typically fabricated from steel, chrome, or tungsten carbide. They are furnished to tolerances ranging from class X to XXX and, when purchased from Edmunds as “Certified,” are directly traceable to the National Institute of Standards and Technology (NIST).



Brief History of Air Gaging

Air gaging is a proven technology which has been refined for over half a century. The first air gages, of the back-pressure type, were developed in France before the Second World War by a carburetor company which needed a method of gaging their carburetor jets.

The firm relied on one of the simplest air regulators ever developed. The first restriction suitably reduced the air pressure and an open-ended tube from a "T" in the air line was submerged in a depth of water. Any air contributing to pressure in excess of the pressure at the depth of water bubbled out the bottom of the tube, through the water and into the atmosphere.

The water column also rose in the indicator tube fed from its bottom, and a second restriction before the "T" in the air line between the top of the indicator tube and the air plug provided zeroing control. As back-pressure affected the level of water in the tube, distance between the air plug nozzles and the workpiece wall was indicated.

In 1943, a patent was issued for the simple system which is the basis of today's back-pressure air gages. One of its important features was the use of the newly-developed pressure regulator, eliminating the evaporation problem of the first system. Also noteworthy is the direct indication of deviations of dimensions by means of a dial readout. At about the same time, another company developed a system for measuring the flow variation rather than the back-pressure.

Improvements in air gaging systems continue to the present, adding the back-pressure bleed and back-pressure differential systems to the roster of simple back-pressure and flow technologies. All four present-day systems will be examined, as well as today's enhancement of measurement precision, flexibility, speed, and usefulness through amplifier technology.

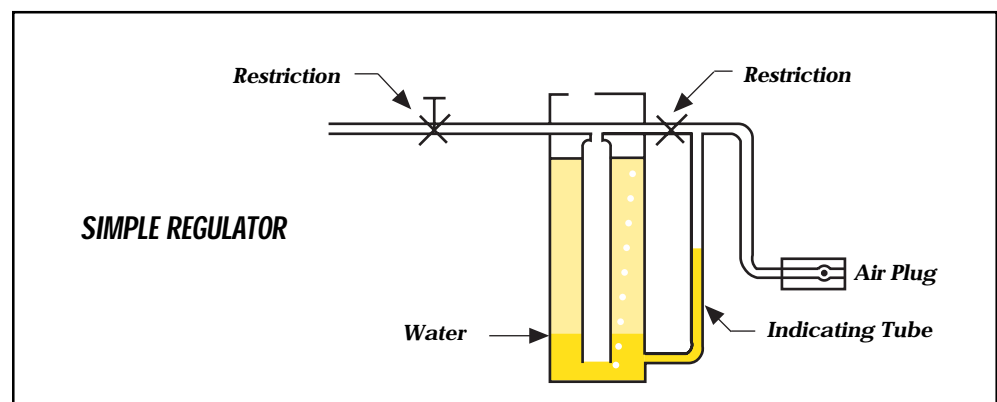

Air Gaging Today

Four general types of air gaging systems are in use today: Back-pressure bleed, back-pressure, differential, and flow. Each has definitive characteristics which affect its diversity of application, accuracy, efficiency, and ability to compensate for degradations of associated tooling.

In addition, air-electronic amplification and data collection/processing have raised the resolution of air gaging to the level of millionths of an inch, while providing output to print hard copies of measurement data and to generate information for statistical process control.



Flat air plug for measuring a groove width



Two-nozzle air plug, with masters, for measuring an inside diameter



Air plug for measuring a taper



Air Gaging Systems

Back-Pressure Bleed System

It is the “bleed” feature in this configuration which accomplishes the back-pressure bleed system’s greatest benefit – its versatility. Tooling for different air gaging systems may be used with the back-pressure bleed. It is because of this high degree of flexibility and accuracy that Edmunds has opted for the back-pressure bleed method as the mainstay of its integrated air gaging systems.

The back-pressure bleed system is configured with a fixed regulator to control incoming air pressure for maximum linearity. Key to this system’s uniqueness is the

all-important addition of a second adjustable restriction in the feed line opposite the output leg. It is this second restriction which allows users to adjust for different air gage tooling.

In addition, the output leg in the Edmunds back-pressure bleed system can actuate one of the two most technologically advanced air-electronic amplifiers available today — the Accu-Setter™ or Trendsetter™ — for simplified operation, reduced set-up time and enhanced data readability.

The system’s magnification is controlled by the typical adjustable restriction between regulator and air tool. The second adjustable restriction releases excess air to the atmosphere to adjust the zero

position. Two setting masters — minimum and maximum — are used to calibrate the system, defining and displaying both ends of the tolerance range for accurate reading of workpiece deviation.

Single master systems indicate with assurance only nominal conformance at the zero point. The back-pressure bleed system defines the tolerance range and indicates explicitly where in that range any workpiece falls. No bad part ever passes.

These systems can also compensate for gradual tool wear or variations in tooling sensitivity, and allows the use of a wide range of nozzle sizes without loss of full amplification.

Back-pressure bleed systems operate at generally higher air pressures than other systems, permitting greater nozzle drop. Nozzles are more protected against wear and damage that can affect measurement accuracy. The higher air pressure also offers better self-cleaning properties.

This system is capable of the broadest magnification adjustment. It accommodates almost any size nozzle, as large as .093" or as small as .020". This is especially beneficial when small nozzles are required to check narrow lands.

An exclusive Edmunds variation on the back-pressure bleed system includes a bias circuit, which eliminates the need for an expensive, precision regulator. Incoming line pressure is split into two legs, one to the usual back-pressure bleed configuration above, the other through a fixed bleed, to an air-electronic pressure differential chip. The output leg is also connected to the chip, which sends its differential signal to the amplifier column. As line pressure varies, the differences between the two legs to the chip cancel each other, maintaining a relative zero regardless of changes in the line pressure.

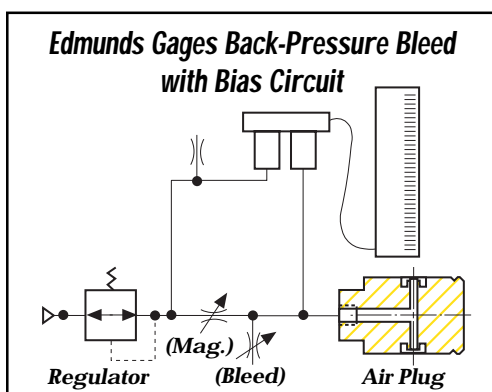
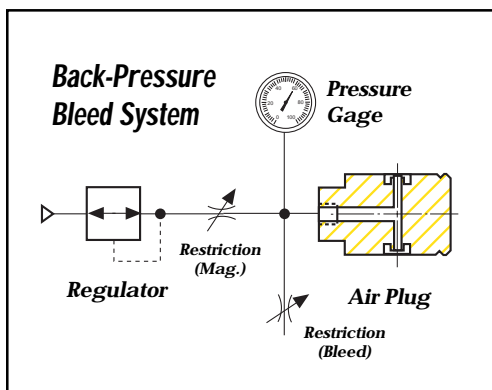

Back-Pressure System

Remove the second adjustable restriction from the back-pressure bleed system, and that is the back-pressure system. This two-master system operates just as the back-pressure bleed without the tooling versatility benefit. The back-pressure system requires dedicated tooling and amplifiers with limited ranges.

Differential System

In this system, sometimes referred to as a “balanced” system, the air stream is divided and flows through two fixed restrictions. One side of the system, the bleed leg, ends in a zero valve which balances pressure to the fixed second leg of the system, terminating at the air plug. The difference between these two legs is measured by means of the differential pressure meter which bridges the legs.

The differential system is set to zero using a single master for each tooling configuration, making set-up somewhat faster. However, the differential system amplifier can only be set to zero. Damaged or worn tooling could result in inaccurate readings. Plus with a single master system, the entire amplifier must be calibrated instead of just the masters as in two-master systems.

Tooling for the back-pressure differential system needs be ordered for each particular magnification. Because the single-master system has fixed magnification, worn, damaged or fouled tooling must be returned to the manufacturer for service. Another drawback of this system is that each amplifier only accommodates one full scale value. If an application requires the measurement of different tolerances, several amplifiers may be necessary.

Flow System

As in the simple flow circuit discussed earlier, the air flow variation is measured and read in a flowmeter tube which supports a float. It is a two-master system, with magnification and zero position set by two adjustable restrictions. As such, the flow system provides accuracy in reporting workpiece deviations within tolerance, similar to the back-pressure bleed system. The range of magnification is augmented by changing flow tubes and scales, rather than by a simple adjustment.

Flow gages, by their nature, require a greater volume of air to generate movement of the float. This requires tooling with larger nozzles, which must be kept closer to the part by designing them with a shallower nozzle drop. Shallow nozzle drops can shorten tool wear life. Also, when the measurement of smaller workpieces necessitates smaller air plugs and smaller nozzles it is difficult to get full amplification.

To its credit, the flow system can be used with long hoses without affecting the response time of the amplifier. This feature makes the flow system ideal for checking long holes, such as gun barrels or oil drill bushings.

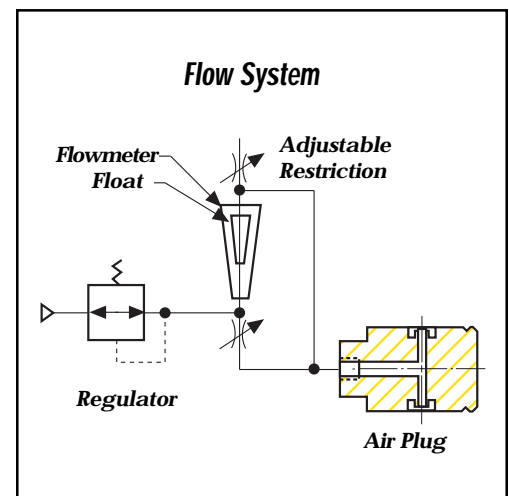
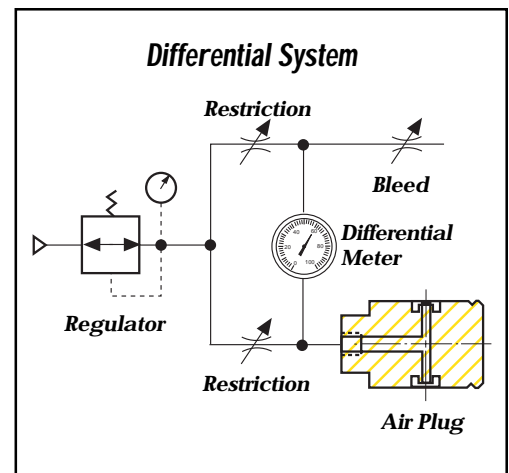
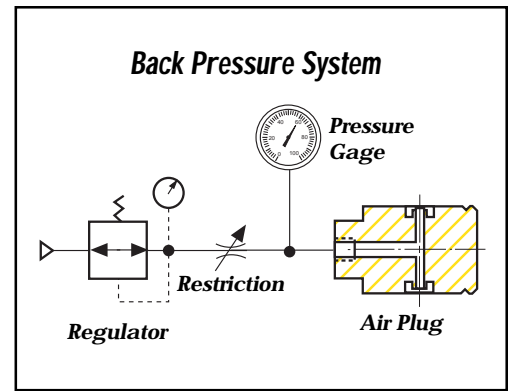



The Edmunds Air Gaging System

Amplifier Columns: The Accu-Setter™ and the Trendsetter™

Edmunds amplifiers combine the best in column design with Edmunds-only features that clearly put them a step ahead of all others in time savings and usefulness.

Interchangeable signal conditioning modules with 1 or 2 channel air-

electronic inputs allow the use of virtually any air tooling with either column. No out-board transducers are needed in order to gain full air to electronic operation. Two or four channel electronic-only modules are available, as well.

When range is changed, digital scale values change automatically on the 101-active-element L.E.D. bar graph scale. There are no plastic scales to change, so set-up time is drastically reduced. Both columns have simplified signal routing to a 10-channel matrix bus for multi-column set-ups, and are housed in heavy duty, reinforced aluminum cases.

Detailed information, in addition to the following descriptions, is available in separate Accu-Setter and Trendsetter catalogs.

The Accu-Setter Gaging Column

The Edmunds Accu-Setter is the most technologically advanced air-electronic gaging column available today. Its microprocessor base and expertly engineered features assure users of producing quality, in-tolerance parts, day in and day out. The Accu-Setter is designed for simplified operation, reduced set-up time, and enhanced display readability. No other column offers as much sophistication and versatility at Edmunds' competitive price.



Accu-Setter features:

- Single button operation — simply “rotate to view” function choices, and “push to select.”
- Easy-to-read L.E.D. alphanumeric display prompts users step-by-step through set-up and gaging functions.
- 3-in-1 column capability in one easy-to-use unit. Accu-Setter may be user-configured for up to three dimensional features to be measured at once.
- Results provided three ways: as good and bad indicators; variable deviations from a nominal; or as absolute numeric values.
- Readings displayed inch or metric.
- Operates with Edmunds high quality tooling or most major brand tooling, so tooling investment is protected.
- Both bar graph and digital displays provided.
- RS-232 output for downloading information to a printer or computer.

Accu-Setter Scales

Full Scale		Graduations	
(in.)	(mm)	(in.)	(mm)
.0002	.005	.000002	.00005
.0005	.01	.000005	.0001
.001	.02	.000010	.0002
.002	.05	.000020	.0005
.005	.1	.000050	.001
.010	.2	.0001	.002

The Trendsetter Gaging Column

The Edmunds Trendsetter gaging column is a solid state unit with quickly interchangeable input modules with or without limit lights. A specialized universal amplification circuit allows the Trendsetter to use many brands of air tooling. Other modules provide TIR indication, sum/difference average, classifying, and other options.

The Trendsetter features three elements at each end of the bar scale which flash to indicate when the gaging signal goes beyond range, and module lights which show the mode in use, inch or metric, and a panel switch to select any of five operating ranges in each mode for air gaging.



Trendsetter Scales

Full Scale		Graduations	
(in.)	(mm)	(in.)	(mm)
.0005	.01	.000005	.0001
.001	.02	.000010	.0002
.002	.05	.000020	.0005
.005	.1	.00050	.001
.010	.2	.0001	.002



Back-Pressure Bleed System Tooling

Air Plugs

Edmunds provides a range of styles to match your application — for deep or shallow holes, for thru-holes, blind holes, and close to shoulder measuring. Our leaf contact design is ideal for checking parts with inconsistent surface finishes.

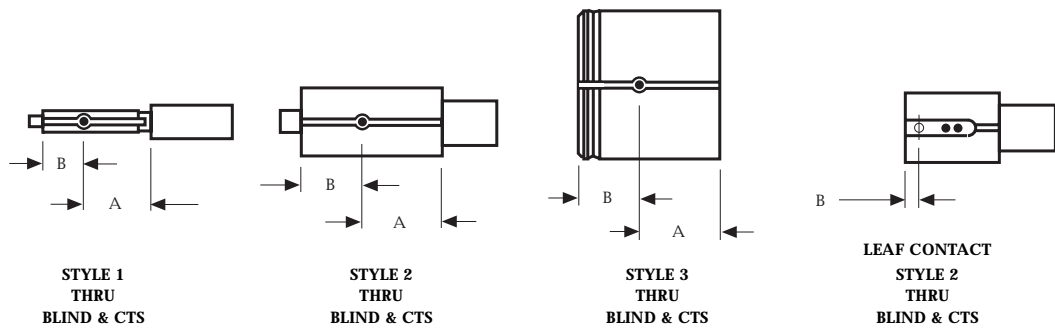

SIZE RANGE				Style	DIMENSIONS				Leaf Thru B	Blind & CTS B	Maximum Number of Nozzles	Nozzle Sizes	Maximum Measuring Range	Thread
Inches Above	Inches To and Inc.	Millimeters Above	Millimeters To and Inc.		Thru A	Thru B	Blind & CTS A	Blind & CTS B						
.120	.162	3.05	4.11	1	.625	.375	.625	.062	-	2	.025	.0014	10-32	
.162	.296	4.11	7.52	1	.625	.375	.625	.062	-	2	.032	.002	10-32	
.296	.480	7.52	12.19	2	1.000	.750	1.000	.093	-	3	.043	.003	10-32	
.480	.573	12.19	14.55	2	1.000	.750	1.000	.093	-	3	.043	.003	1/4-28	
.573	.850	14.55	21.59	2	1.000	.750	1.000	.093	.750	4	.052	.005	1/4-28	
.850	1.510	21.59	38.35	2	1.000	.750	1.000	.093	.750	6	.052	.005	1/2-20	
1.510	2.010	38.35	51.05	2	1.000	.750	1.000	.093	.750	6	.052	.005	1/2-20	
2.010	6.010	51.05	152.65	3	1.000	.750	1.000	.093	.750	6	.052	.005	1/2-20	

For larger or smaller plug sizes or special nozzle sizes, please consult Edmunds.

Understanding Tool Marking

Edmunds has devised a simple way to identify air plugs. Here is an explanation of our marking system:

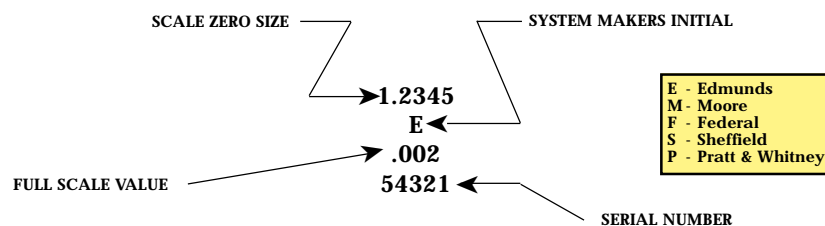

Air Rings

Edmunds precision air rings are made of a hardened steel, chrome-plated or carbide inner ring — the gaging surface — and an aluminum outer ring for lightweight, hand-held gaging. We offer thru-hole and close-to-shoulder styles in a variety of sizes and number of nozzles.



Back-Pressure Bleed Scales

Full Scale (in.)

- .010
- .006*
- .005
- .004*
- .003*
- .002
- .0014*
- .001
- .0008*
- .0006*
- .0005
- .0004*
- .0002

*Replacement tooling only

Air Ring with Guide Posts

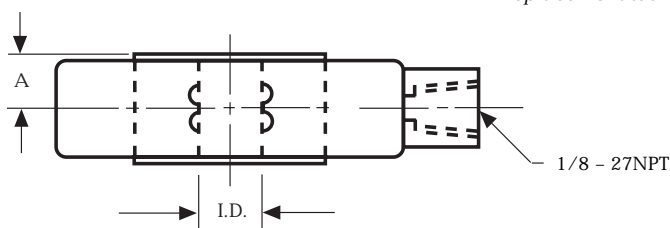

SIZE RANGE				DIMENSIONS		Maximum Number of Nozzles	Nozzle Sizes	Maximum Measuring Range
INCHES	MILLIMETERS	INCHES	MILLIMETERS	Thru A	CTS A			
Above	To and Inc.	Above	To and Inc.					
.120	.180	3.05	4.57	.406	.065	2	.032	.002
.180	.350	4.57	8.89	.406	.065	2	.043	.003
.350	.560	8.89	14.22	.406	.065	4	.043	.003
.560	1.010	14.22	25.65	.406	.065	6	.052	.005
1.010	1.510	25.65	38.35	.468	.065	6	.052	.005
1.510	2.010	38.35	51.05	.468	.065	6	.052	.005
2.010	2.510	51.05	63.75	.468	.065	6	.052	.005
2.510	3.010	63.75	76.45	.562	.065	6	.052	.005
3.010	6.010	76.45	152.65	.625	.065	6	.052	.005

For larger ring sizes or special nozzle sizes, please consult Edmunds.

Back-Pressure Bleed Connections

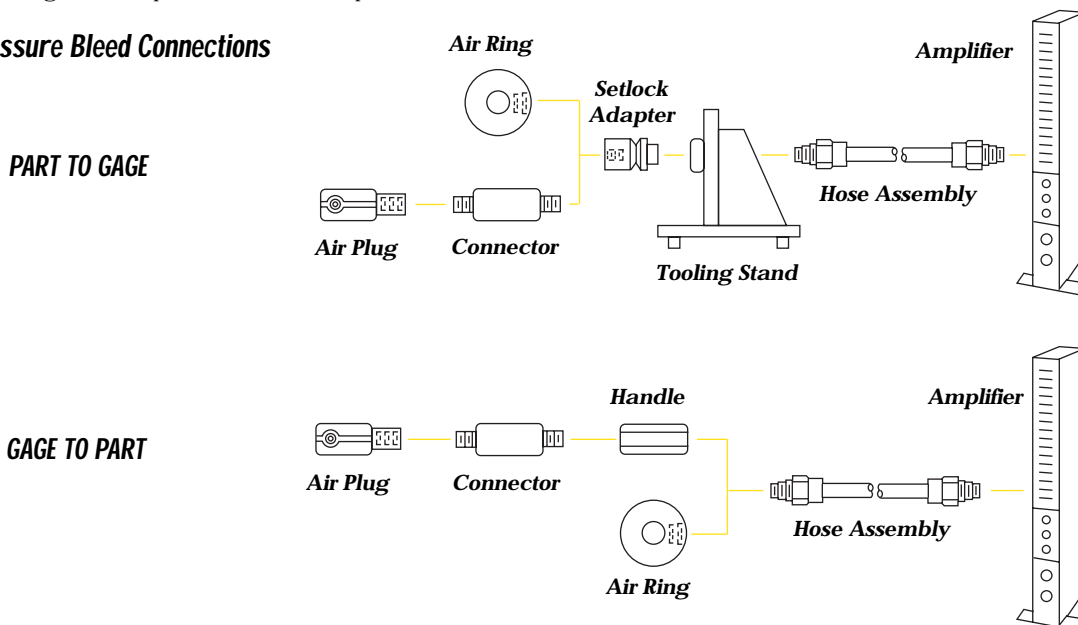



Back-Pressure System Tooling

Air Plugs

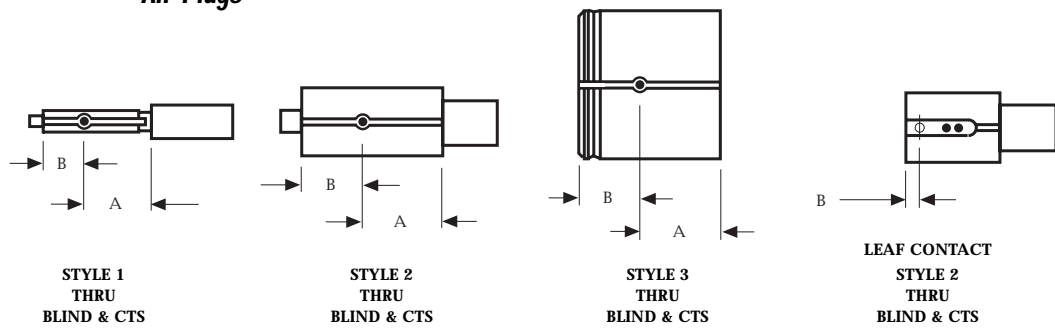

SIZE RANGE				Style	DIMENSIONS				Leaf		Maximum Number of Nozzles	Nozzle Sizes	Maximum Measuring Range	Thread
INCHES		MILLIMETERS			Thru		Blind & CTS		Thru B	Blind & CTS B				
Above	To and Inc.	Above	To and Inc.	A	B	A	B							
.120	.162	3.05	4.11	1	.625	.375	.625	.062	-	-	2	.025	.0014	10-32
.162	.296	4.11	7.52	1	.625	.375	.625	.062	-	-	2	.032	.002	10-32
.296	.480	7.52	12.19	2	1.000	.750	1.000	.093	-	-	3	.043	.003	10-32
.480	.573	12.19	14.55	2	1.000	.750	1.000	.093	-	-	3	.043	.003	1/4-28
.573	.850	14.55	21.59	2	1.000	.750	1.000	.093	.375	.156	4	.043	.003	1/4-28
.850	1.510	21.59	38.35	2	1.000	.750	1.000	.093	.375	.156	6	.043	.003	1/2-20
1.510	2.010	38.35	51.05	2	1.000	.750	1.000	.093	.375	.156	6	.043	.003	1/2-20
2.010	6.010	51.05	152.65	3	1.000	.750	1.000	.093	.375	.156	6	.043	.003	1/2-20

For larger or smaller plug sizes or special nozzle sizes, please consult Edmunds.

Air Rings

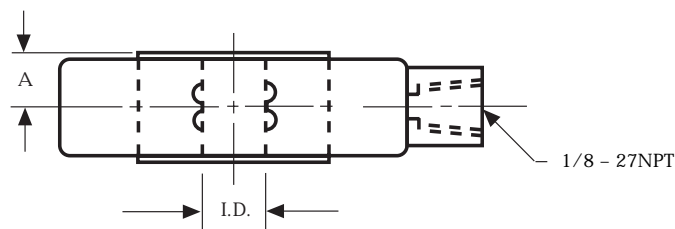

SIZE RANGE				DIMENSIONS		Maximum Number of Nozzles	Nozzle Sizes	Maximum Measuring Range
INCHES		MILLIMETERS		Thru A	CTS A			
Above	To and Inc.	Above	To and Inc.					
.120	.180	3.05	4.57	.406	-	2	.032	.002
.180	.350	4.57	8.89	.406	-	2	.043	.003
.350	.560	8.89	14.22	.406	.065	4	.043	.003
.560	1.010	14.22	25.65	.406	.065	6	.043	.003
1.010	1.510	25.65	38.35	.468	.065	6	.043	.003
1.510	2.010	38.35	51.05	.468	.065	6	.043	.003
2.010	2.510	51.05	63.75	.468	.065	6	.043	.003
2.510	3.010	63.75	76.45	.562	.065	6	.043	.003
3.010	6.010	76.45	152.65	.625	.065	6	.043	.003

For larger ring sizes or special nozzle sizes, please consult Edmunds.

Back-Pressure System Scales

FULL SCALE (in.)	Compact	H & K - series	G - 21	G-35	G-70
.003	•	•	•	-	-
.002	•	•	•	-	-
.0016	-	-	•	-	-
.0015	•	•	-	-	-
.001	•	•	-	-	-
.0008	•	•	•	•	-
.0004	-	-	-	•	•
.0002	-	-	-	-	•

Back-Pressure System Connections

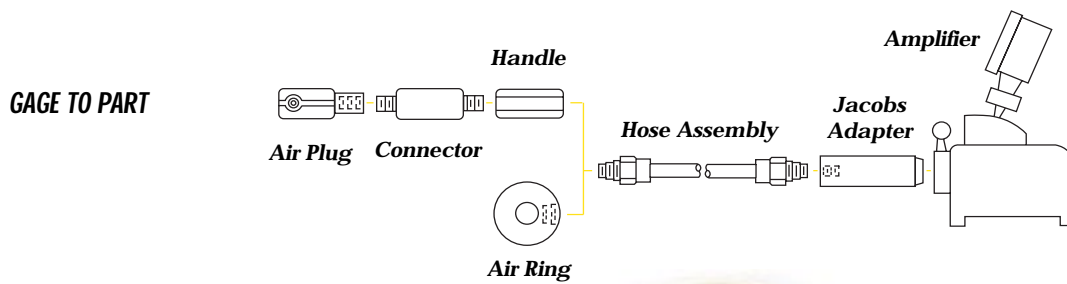
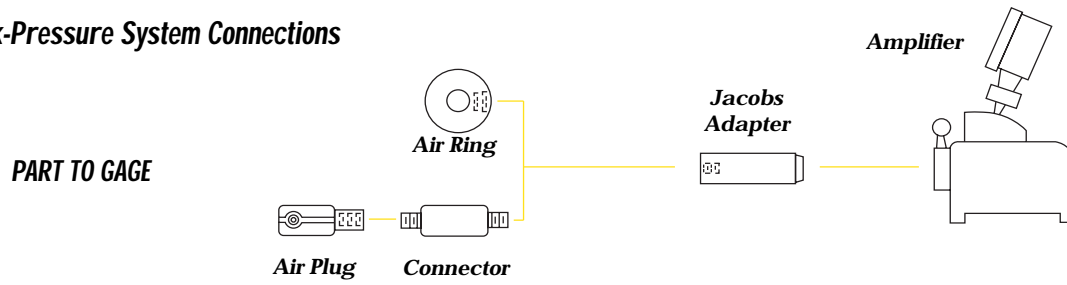



Flow System Tooling

Air Plugs

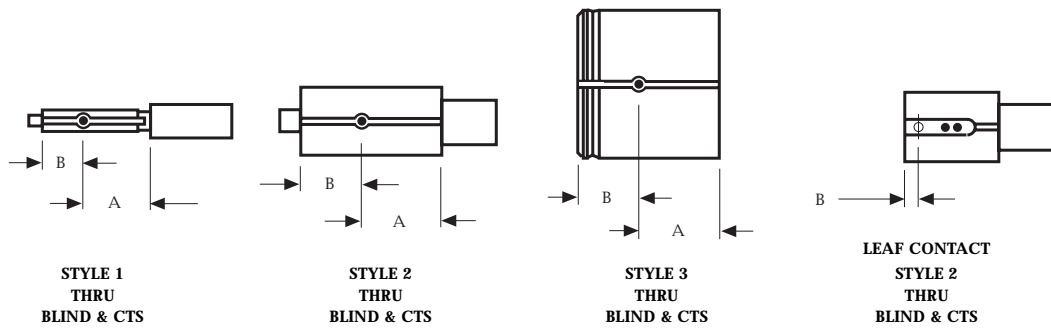

SIZE RANGE				Style	DIMENSIONS				Leaf		Maximum Number of Nozzles	Nozzle Sizes	Amp	Thread
INCHES		MILLIMETERS			Thru		Blind & CTS		Thru B	Blind & CTS B				
Above	To and Inc.	Above	To and Inc.	A	B	A	B							
.120	.162	3.05	4.11	1	.625	.375	.625	.062	-	-	2	.043	3/4	10-32
.162	.296	4.11	7.52	1	.625	.375	.625	.062	-	-	2	.043	3/4	10-32
.296	.480	7.52	12.19	2	1.000	.750	1.000	.093	-	-	3	.078	Full	10-32
.480	.573	12.19	14.55	2	1.000	.750	1.000	.093	-	-	3	.078	Full	1/4-28
.573	.850	14.55	21.59	2	1.000	.750	1.000	.093	.375	.156	4	.078	Full	1/4-28
.850	1.510	21.59	38.35	2	1.000	.750	1.000	.093	.375	.156	6	.078	Full	1/2-20
1.510	2.010	38.35	51.05	2	1.000	.750	1.000	.093	.375	.156	6	.078	Full	1/2-20
2.010	6.010	51.05	152.65	3	1.000	.750	1.000	.093	.375	.156	6	.078	Full	1/2-20

For larger or smaller plug sizes, please consult Edmunds.

Air Rings

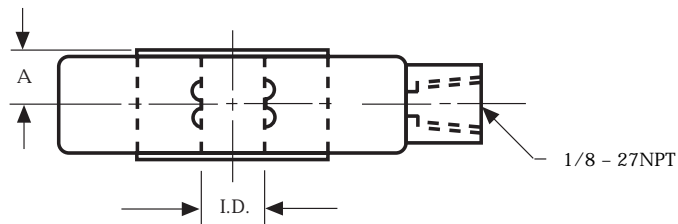

SIZE RANGE				DIMENSIONS		Maximum Number of Nozzles	Nozzle Sizes	Amp
INCHES		MILLIMETERS		Thru A	CTS A			
Above	To and Inc.	Above	To and Inc.					
.120	.180	3.05	4.57	.406	.065	2	.032	1/2
.180	.350	4.57	8.89	.406	.065	2	.043	3/4
.350	.560	8.89	14.22	.406	.065	4	.043	3/4
.560	1.010	14.22	25.65	.406	.065	6	.078	FULL
1.010	1.510	25.65	38.35	.468	.065	6	.078	FULL
1.510	2.010	38.35	51.05	.468	.065	6	.078	FULL
2.010	2.510	51.05	63.75	.468	.065	6	.078	FULL
2.510	3.010	63.75	76.45	.562	.065	6	.078	FULL
3.010	6.010	76.45	152.65	.625	.065	6	.078	FULL

For larger ring sizes, please consult Edmunds.



Flow System Scales

AMPLIFICATION		FULL SCALE (in.)	MAXIMUM MEASURING RANGE (in.)
2M	2,000:1	.0045	.003
5M	5,000:1	.0018	.0012
10M	10,000:1	.0009	.0006
20M	20,000:1	.00045	.0003
2M		@3/4 AMP	.004
5M		@3/4 AMP	.0016
10M		@3/4 AMP	.0008
20M		@3/4 AMP	.0004

Flow System Connections

PART TO GAGE

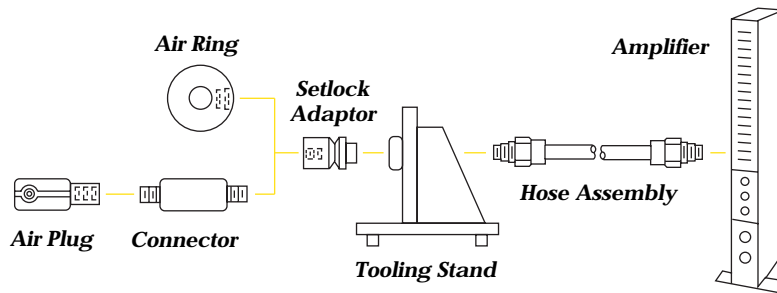

GAGE TO PART

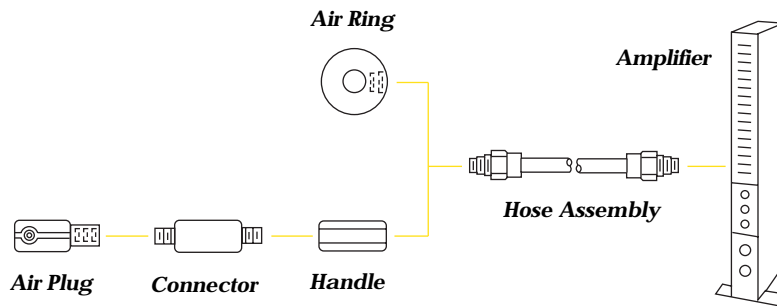



Differential System Tooling

Air Plugs

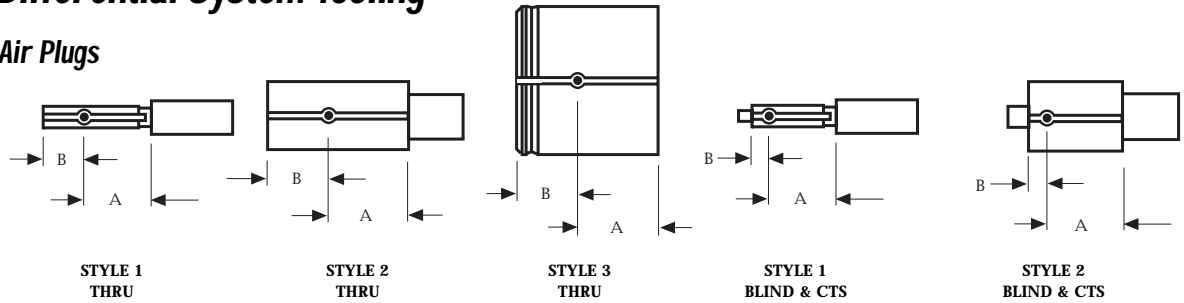

SIZE RANGE				Style	DIMENSIONS				Maximum Number of Nozzles	Max. Measuring Range		Thread
INCHES		MILLIMETERS			Thru		Blind & CTS			D-2500 D-4000	D-5000 D-8000	
Above	To and Inc.	Above	To and Inc.		A	B	A	B				
.165	.187	4.19	4.76	1	.625	.625	-	-	2	.0015	.00075	3/8-32
.187	.202	4.76	5.13	1	.625	.625	-	-	2	.002	.0010	3/8-32
.202	.262	5.13	6.65	1	.625	.375	.625	.093	2	.002	.0010	3/8-32
.262	.296	6.65	7.51	1	.625	.375	.625	.093	2	.003	.0015	3/8-32
.296	.573	7.51	14.55	1	1.000	.750	1.000	.093	2	.003	.0015	3/8-32
.573	.636	14.55	16.15	1	1.000	.750	1.000	.093	3	.003	.0015	3/8-32
.636	2.010	16.15	51.05	2	1.000	.750	1.000	.093	3	.003	.0015	3/8-32
2.010	6.010	51.05	152.65	3	1.000	.750	1.000	.093	3	.003	.0015	3/8-32

For larger or smaller plug sizes or special nozzle sizes, please consult Edmunds.

Air Rings

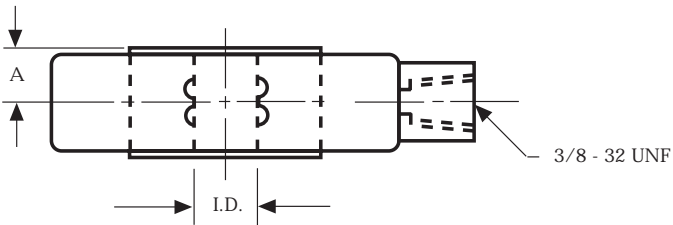

SIZE RANGE				DIMENSIONS		Maximum Number of Nozzles	Maximum Measuring Range	
INCHES		MILLIMETERS		Thru A	CTS A		D-2500 D-4000	D-5000 D-8000
Above	To and Inc.	Above	To and Inc.					
.350	.560	8.89	14.22	.406	.065	3	.002	.0010
.560	1.010	14.22	25.65	.406	.065	3	.003	.0015
1.010	1.510	25.65	38.35	.468	.065	3	.003	.0015
1.510	2.010	38.35	51.05	.468	.065	3	.003	.0015
2.010	2.510	51.05	63.75	.468	.065	3	.003	.0015
2.510	3.010	63.75	76.45	.562	.065	3	.003	.0015
3.010	6.010	76.45	152.65	.625	.065	3	.003	.0015

For larger ring sizes, please consult Edmunds.

Differential System Connections

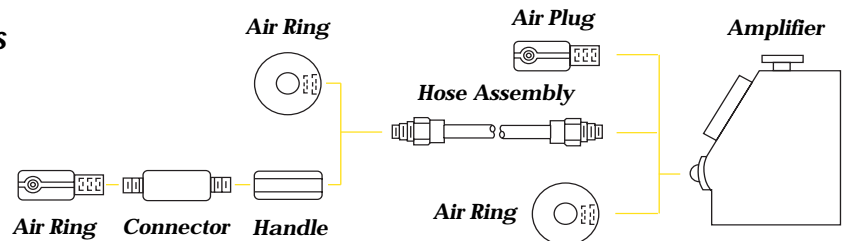

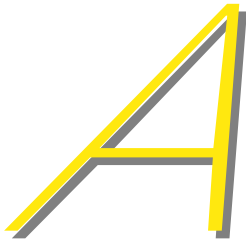

Air Snaps, Masters and Accessories

Custom Air Snaps

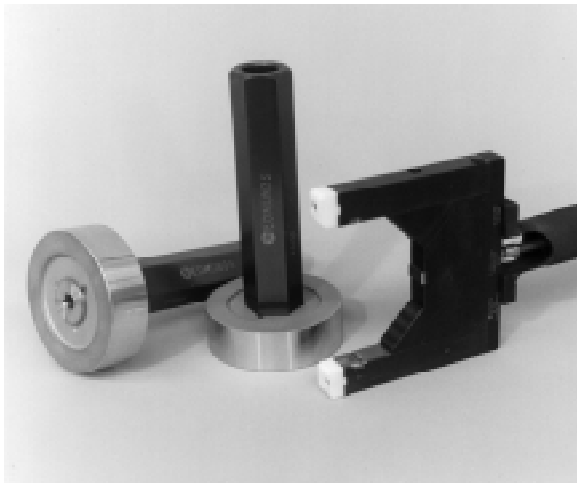

Edmunds air snap tooling is custom designed to suit your application. Air snaps are designed for those difficult to reach or “between centers” diameter measurements. Often, air snaps gage a part while it is engaged in the machine tool. They feature rugged tungsten carbide rest pads for long wear, and a lightweight aluminum handle. Available for use with all air gaging systems, Edmunds air snaps have a proven record of reliability and endurance. They are offered with up to three circuits, and a vee-type backstop may also be specified.

Master Setting Rings and Discs

Providing ultra-precise setting masters is an integral part of a quality air gaging system. At Edmunds, we take special care in the manufacturing of these components. Crafted from quality steel, hard chrome, or solid tungsten carbide, our masters are stabilized, precision lapped to within millionths of an inch and when purchased from us as “Certified,” are directly traceable to the NIST. All of our gaging products are inspected under strict laboratory conditions that assure optimum measurement accuracy.

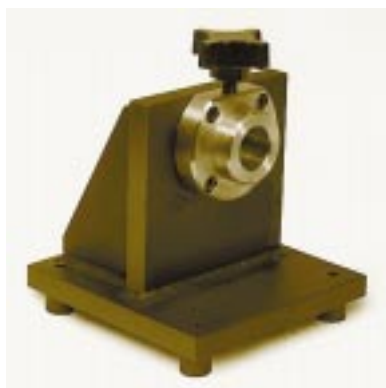

Tooling Stands

Edmunds tooling stands are made of welded steel to provide a rigid and stable base for horizontal mounting of air plugs or rings. They are available with proven, brand-name chucks. The single tooling stand has a 5" x 5" footprint. The dual tooling stand has a 5" x 12" footprint.



Loaders

Edmunds makes positioning and removal of thin workpieces simple with our workpiece loaders. They mount directly to an air ring and provide a square, transversing anvil for accurate and stable part location.

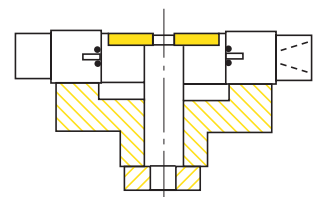

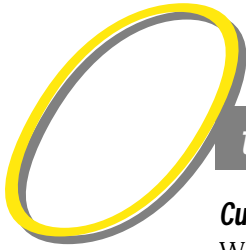

ther Edmunds Products and Services

Custom Design and Build

Whether you need a single or multi-dimensional fixture, hand-held gages or a completely automatic gaging system, Edmunds can furnish it. We've already produced thousands of special designs from cylindrical gages to fully-automatic, computerized, post-process gaging systems.

Computer Aided Gaging (CAG™) Microprocessors

Our CAG™ system offers a computer-based readout and data gathering abilities in a convenient, industrial-designed package. This proven system can be applied to manual or automatic gages requiring up to 32 inputs. The Micro CAG™ is a similar and smaller version of the same menu-driven, user-friendly CAG with up to 8 inputs.

Electronic Amplifiers

Edmunds Accu-Setter™ electronic column amplifier features single-button operation, L.E.D. digital alphanumeric display and 3-in-1 column capability to allow simplified operation, reduced setup time and at-a-glance monitoring of part measurement. Accommodates 2 or 4 channel electronic or 1 or 2 air-electronic inputs.

Our Trendsetter™ electronic column has quickly interchangeable plug-in modules for a variety of gaging needs. Ten-inch scale has digital scale values. Choice of inch or metric ranges. Works with almost every make of air or electronic tooling.

Cylindrical Gages

Complete line of inch or metric plain ring gages, setting discs plus plain, progressive or reversible plug gages in AGD classes Z through XXX. Choice of materials, including steel, chrome or carbide.

Universal Comparators

The standard of accuracy, our comparator is universal for comparative ID, OD, and length measurement with resolution of .000001". Auto-zeroing eliminates time-consuming setting of meters. The preferred instrument in most calibration labs.

Gage Block Comparators

Single and twin-head, capacities up to 20", resolution to 1/10 of one millionth of an inch (.0000001"). Unique functional features, such as "click stop" for rapid head positioning and auto zeroing save time.

Calibration Service

Traceable calibration and certification for all classes of plug, ring, or setting discs, including XXX. Gage blocks calibrated with or without replacement block service. All certification conforms to the most current Federal guidelines and is traceable to the NIST.



Air Gage Ordering Worksheet

For your convenience, copy this form and fax with your purchase order to
Edmunds Gages, (860) 677-4243

Air Plug(s) _____ (quantity) **Air Ring(s)** _____ (quantity)

Number of nozzles required: _____

Air gage type: _____ (thru-hole, blind-hole, close-to-shoulder)

Air gage style: _____ (open jet, leaf contact)

Material: _____ (steel, chrome, carbide)

Check sizes: _____ Max. _____ Min.

Zero size: _____

Air gaging system used: Edmunds ____ Other (please specify) _____

Stand/model: _____ Full scale value _____

Air plug length(s) required: Standard _____

Special: A _____ B _____

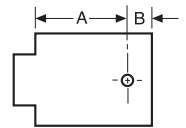

Air ring nozzle location: Standard: _____

Special: A _____

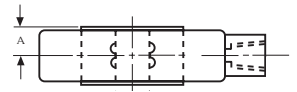

Special marking required: _____

Material of gaged parts: _____

Masters required? _____

Master Rings: Material _____ Class _____ (XX, X, other)

Sizes: Max. _____ Min. _____ Mean _____

Master setting disc: Material _____ (steel, chrome, carbide)

Class _____

Sizes: Max. _____ Min. _____ Mean _____

Certification of size required? _____

Unless otherwise specified, all masters will be bilateral tolerance.



Farmington Industrial Park,
Farmington, CT USA 06032
TEL (860) 677-2813
FAX (860) 677-4243